

# ANTLER

## Cot Fastener System

### Technical.Service.Bulletin



To our valued Stryker customer,

It is important to implement a preventive maintenance program to keep your product performing to specification. This bulletin details some of the installation, operation and maintenance information that is imperative to ensure that your ambulance cot and fastener are operating to specification. Failure to properly install, operate and maintain these products could result in operator or patient injury. The information provided in this bulletin can also be found in your product's operations and maintenance manual.

For more information contact your local Account Manager, call 800 784 4336 or visit [ems.stryker.com](http://ems.stryker.com).

For product operation and maintenance manuals please call 800 784 4336 and select Option 2 for Technical Support.

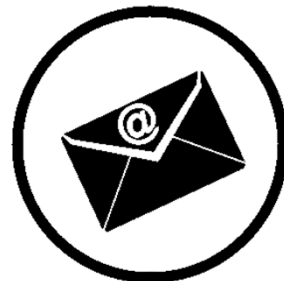

# Antler Cot Fastener System

The Stryker Model **6370/6371/6377/6378/6391** cot fasteners are designed to restrict movement of an ambulance cot being transported in the patient compartment of an ambulance under normal conditions. Caution must be used at all times during placement of the cot into the ambulance.

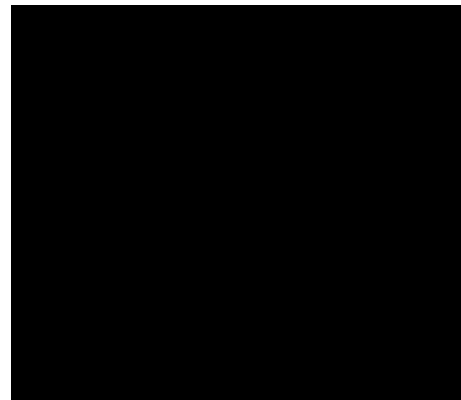
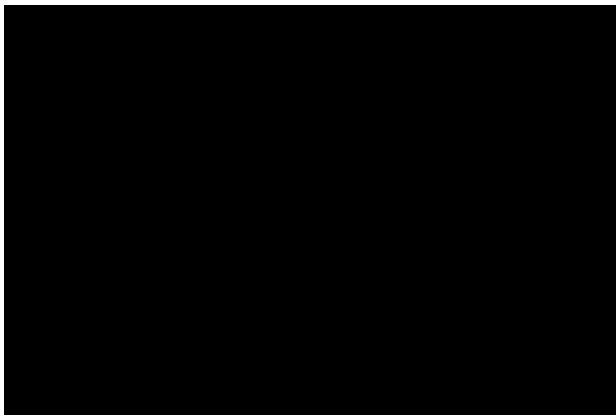
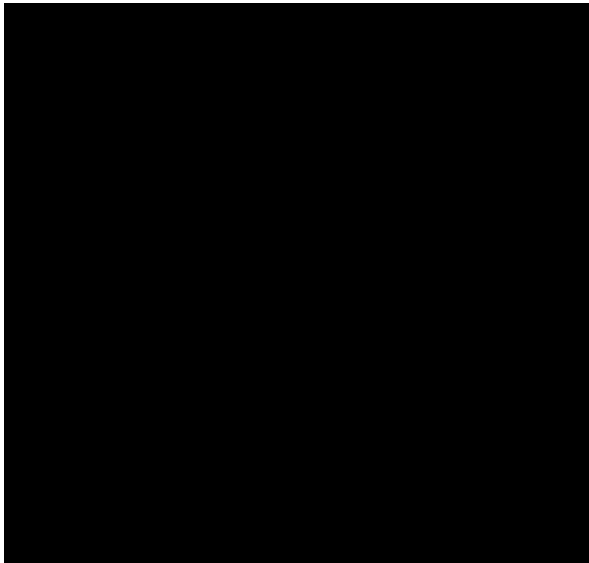

# Technical Service Bulletin

This bulletin will address the following:

- 1. Cot Fastener Installation**
- 2. Cot Fastener Operation**
- 3. Cot Fastener Maintenance**
- 4. Cot Retaining Post Maintenance**
- 5. Safety Hook Installation**
- 6. Safety Hook Inspection**
- 7. Safety Hook Maintenance**
- 8. Maintenance Schedules**
  - Cot Fasteners
  - Power-PRO™ XT Ambulance Cot
  - MX-PRO® R3 Ambulance Cot

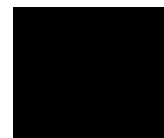
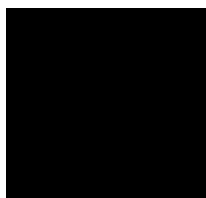

# Cot Fastener Installation

# Cot Fastener Installation

It is the responsibility of the cot operator to ensure that the cot being used in the Stryker Model 6370/6371/6377/6378/6391 Cot Fastener Systems meets the installation specifications shown in **Figure 1** for the floor plate installation and **Figure 2** for the wall plate installation.



Injury may result if a non-compatible cot is used in the Stryker Model 6370/6371/6377/6378/6391 Cot Fastener System.

Figure 1

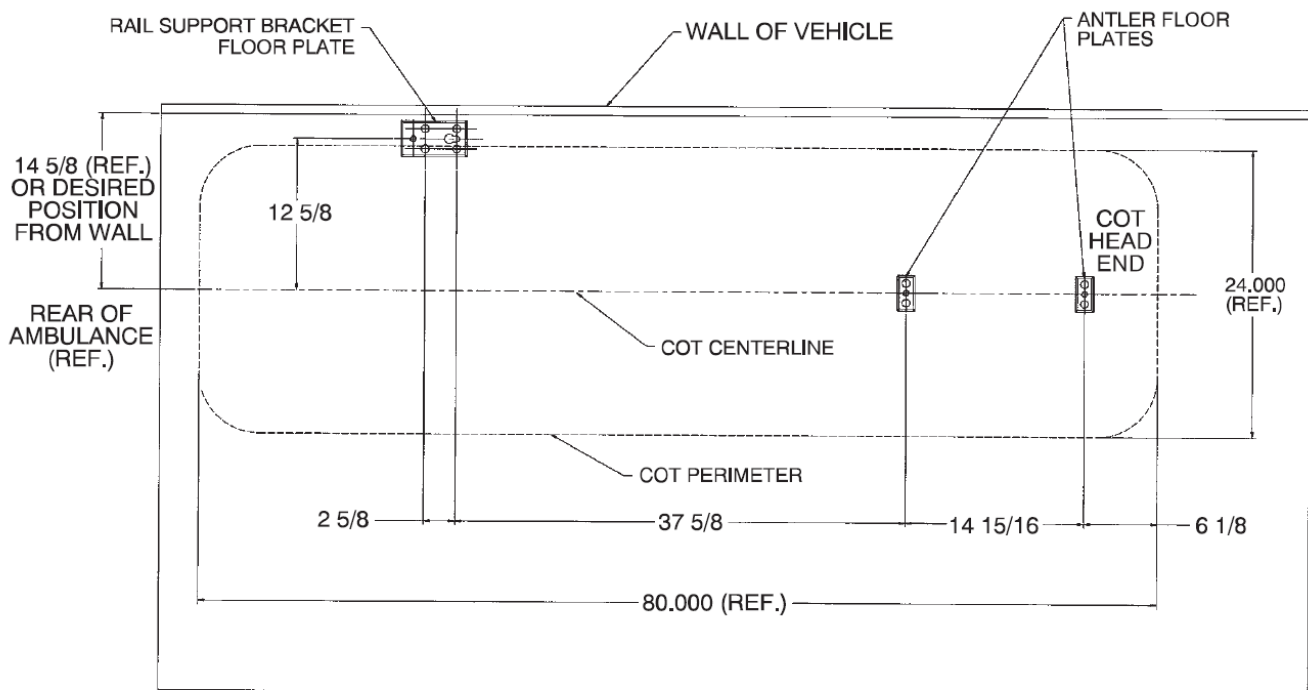

# Cot Fastener Installation

Figure 2

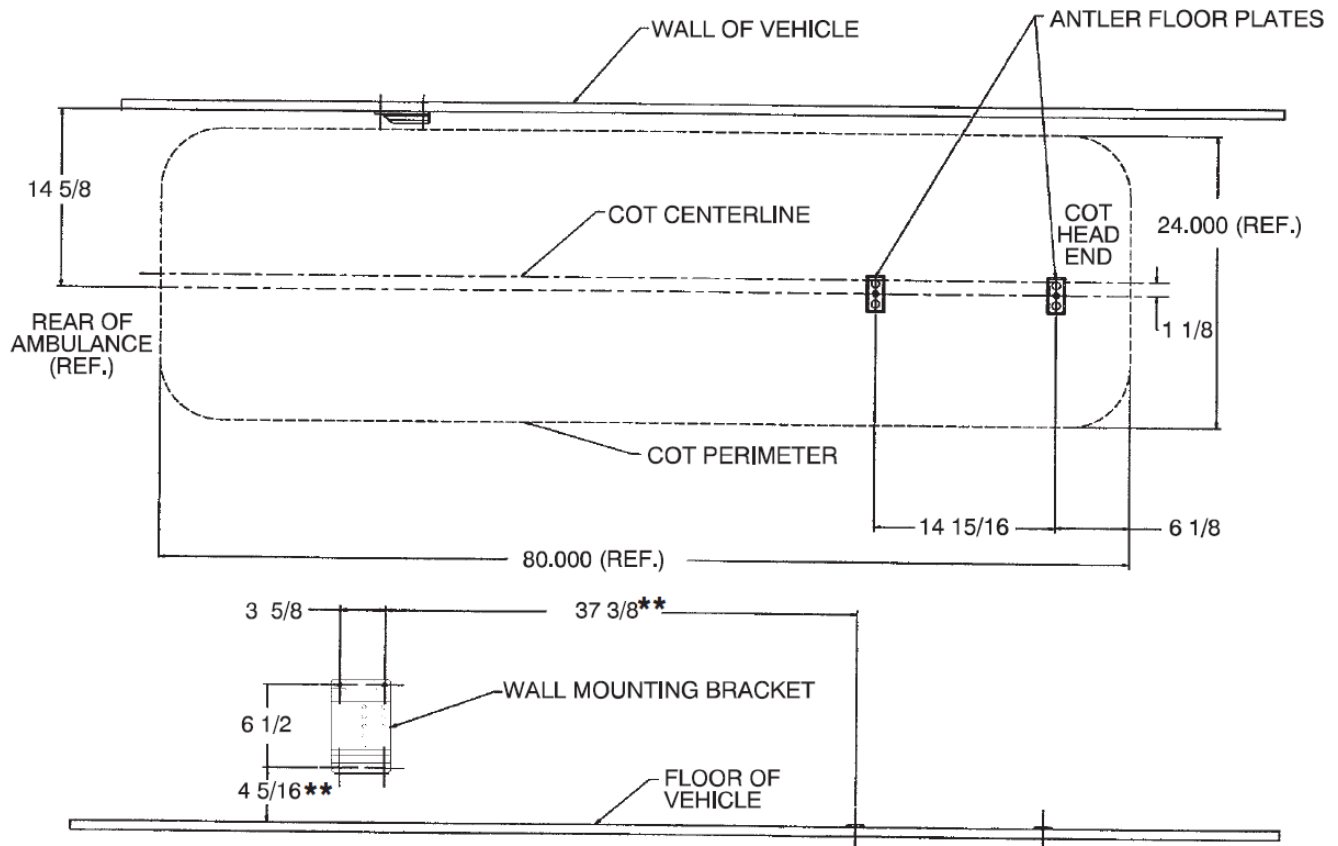

# Cot Fastener Operation Guide

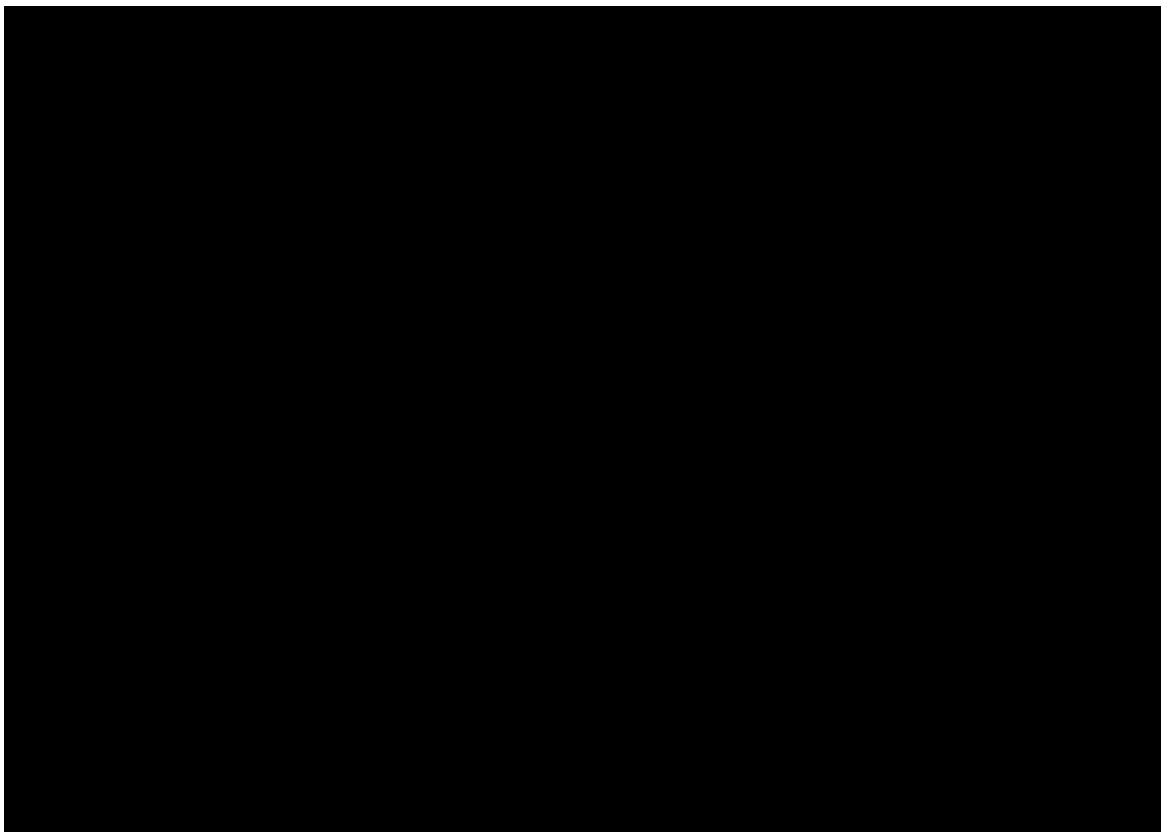

## **Adjusting the Rail Assembly**

Note: Adjustment of the rail clamp assembly may be required in order to compensate for any variation in cot retaining post model number and position. Both depend on the ambulance cot manufacturer and model number.



# Cot Fastener Operation Guide

## To vertically adjust the rail assembly

1. Remove the rail clamp **(A)** and rail assembly **(B)** from the existing mounting holes and move them to the set of holes that align the clamp jaws **(C)** with the post on the cot **(Figure 3)**. Position the rail assembly front/back. Adjustment is limited to 1/2" front/back or 1" total movement. Do not overlap the adjustment limit label **(D)** on the rail assembly **(Figure 3)**. When adjustment is complete, rotate the rail assembly, so the jaws are parallel with the floor and tighten the mounting screws until the rail clamp is drawn firmly against the support bracket.

Figure 3

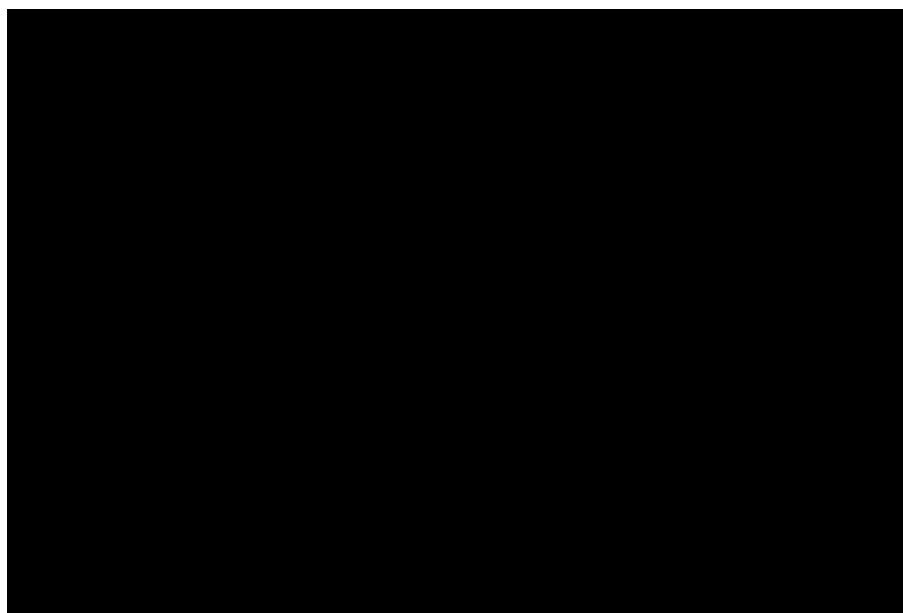

To prevent the cot frame from coming out of the rail jaws, the space between the rail clamp and the rail stationary jaw must never exceed 1". To prevent the cot from coming out of the rail jaws and causing possible injury to the patient or user, the rail clamp must not overlap the red adjustment limit label on the rail tube.

# Cot Fastener Operation Guide

2. To operate the fastener, push the rail handle **(E)** forward until the release button engages and the jaws lock in the open position **(Figure 4)**.

Figure 4

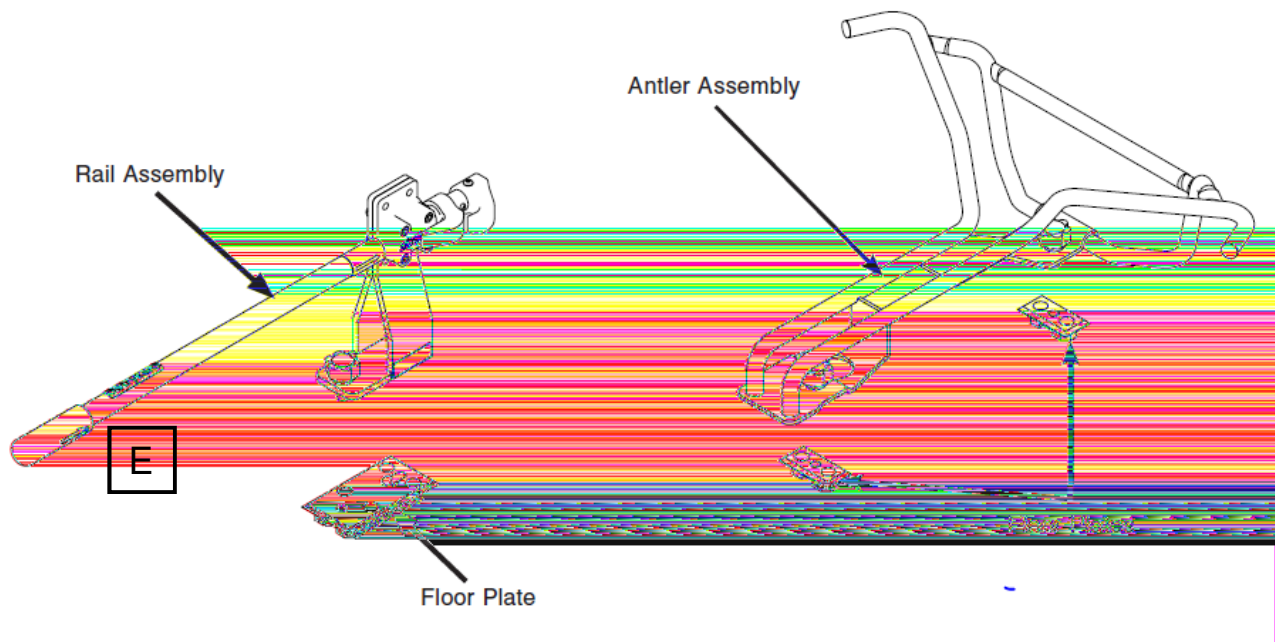

 **WARNING**

The fastener closes with a strong spring action. To avoid injury, do not use hand or fingers to depress the release button when the rail jaws are open.

# Cot Fastener Operation Guide

3. Guide the cot into the fastener at a slight angle, as shown in **Figure 5**, by engaging the loading wheels with the antler. Move the foot end of the cot sideways until the cot post enters the rail jaws and presses the release button. The rail jaws will close, locking the cot securely in position.

Figure 5

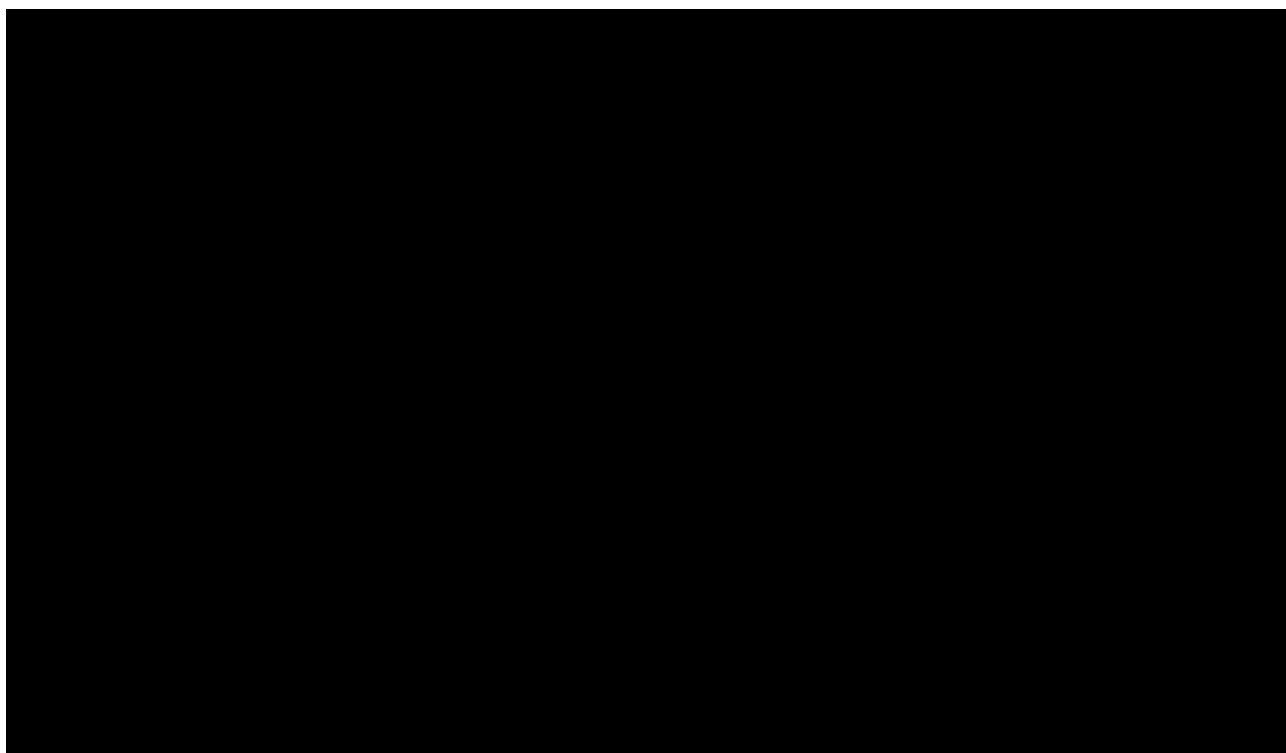

# Cot Fastener Operation Guide

4. Cot bedding may prevent the attendants from seeing the rail jaws close around the cot post. The properly installed and adjusted fastener closes with a “positive” sound and feel that serves as a good indicator of proper engagement. Check for positive engagement by grasping the cot frame and pushing and pulling with sufficient force to disengage the cot if the fastener jaws are not completely closed.

5. To remove the cot, use one hand to actuate the push handle forward far enough for the jaws to release the cot post. With the other hand, grasp the cot and roll it away from the rail.

## Cot Fastener Maintenance

1. Verify proper operation and fit at least every 12 months
2. Verify all fasteners are secure (reference assembly drawings) every 3 months

# Cot Retaining Post Maintenance

## **Power-PRO™ XT Ambulance Cot (Model 6506)**

The following schedule is intended as a general guide to maintenance. Bear in mind that such factors as weather, terrain, geographical location, and individual usage will alter the required maintenance schedule. If you are unsure as to how to perform these checks please contact your Stryker service technician. If you are in doubt as to what intervals to follow in maintaining your product, consult your Stryker service technician. Use the hour meter (page 34 in Cot Fastener Operations/Maintenance Manual) to determine the frequency for preventive maintenance procedures.

Check each routine and replace damaged or worn parts if necessary.

- The cot frame/base should be inspected every 1 month or 2 hours.
- Verify all welds intact, not cracked or broken every 6 months or 12 hours.
- Verify no bent, broken, or damaged components every 6 months or 12 hours.
- Verify all fasteners secure every 3 months or 6 hours.
- Verify that the cot retaining post is secure. If not secure, then the screw must be replaced. See “Cot Retaining Post Screw Replacement” on page 108 in Power-PRO XT Operations/Maintenance Manual.

# Safety Hook Installation

The cot safety bar and vehicle safety hook are designed to keep the cot from being accidentally removed from the vehicle and to provide increased operator assurance and confidence when loading and unloading. The safety hook was designed for compatibility and proper operation when loading and unloading the cot from a vehicle that is compliant with Federal Regulation KKK-A-1822. Improper safety hook installation can cause injury to the patient and/or operator or damage to the cot. The information below can be used to verify placement and maintenance of the safety hook.

Detailed installation instructions can be found in your Operations and Maintenance manual or by contacting Stryker Technical support at 800 784 4336 and select Option 2.

 **WARNING**

- Improper safety hook installation can cause injury to the patient and/or operator or damage to the cot. Have a certified mechanic install the safety hook.
- Failure to install the safety hook can cause injury to the patient or operator. Install and use the safety hook as described in this manual.
- Verify that the safety hook always engages the cot safety bar regardless of how the cot is unloaded from the vehicle or injury to the patient or operator and/or damage to the cot may occur.

# Safety Hook Inspection

## **Side to side positioning of the safety hook**

1. Remove the cot from the fastener and unload it from the vehicle.
2. While the cot is being removed, note the position of the load wheels and the safety bar.
3. Mark the center of the cot safety bar on the vehicle floor.
4. Verify that the position marked in Step 3 is where the safety bar engages the safety hook every time when unloading the cot in a variety of positions (all the way to the left and all the way to the right), regardless of cot position.
  - If the cot safety bar does not engage the safety hook in any of these positions (left, center, or right), modify the vehicle, not the cot or safety hook.
  - If the cot safety bar engages the safety hook every time, install the safety hook.

# Safety Hook Inspection

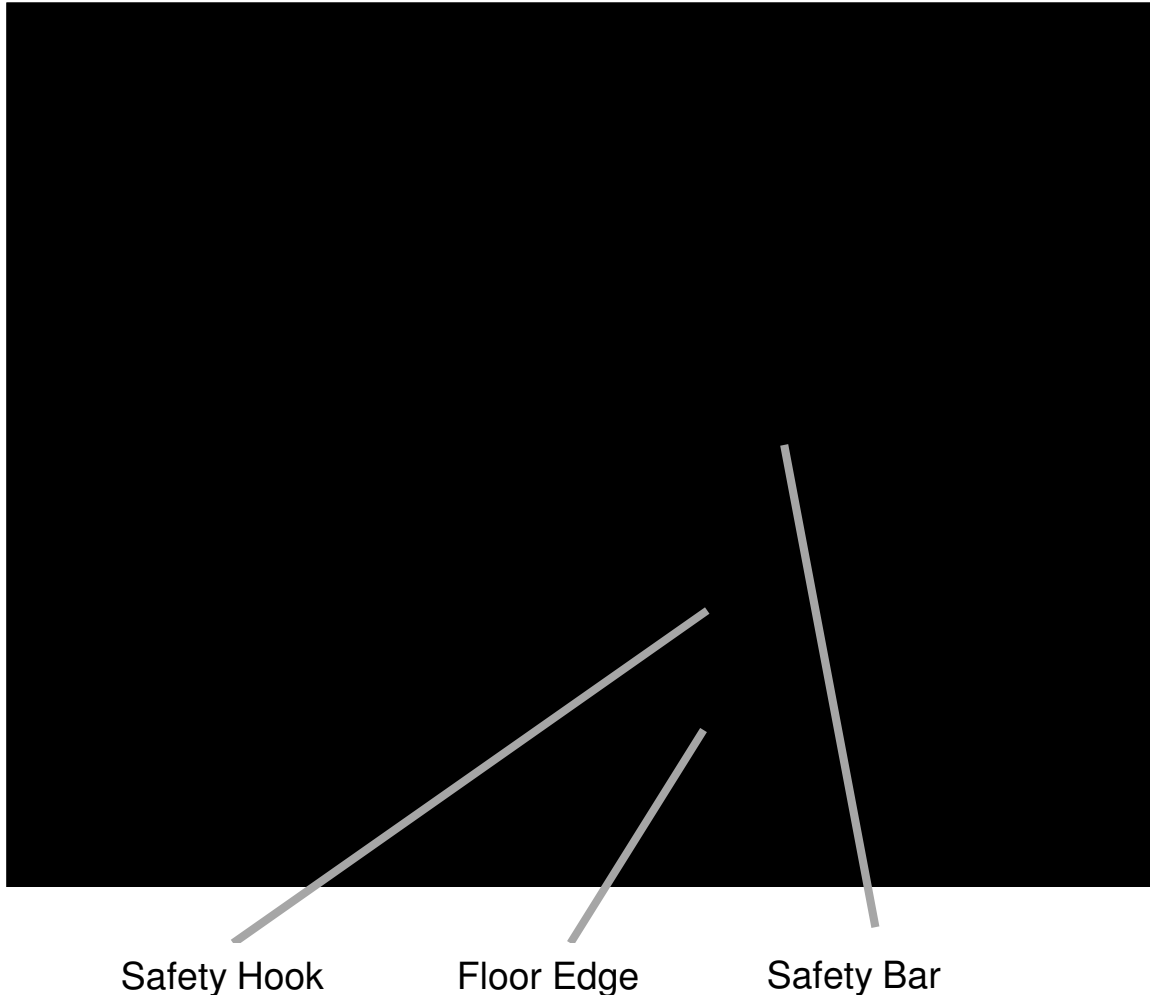

## Safety Hook Maintenance

Verify the safety bar engages the vehicle safety hook properly every 12 months.



# Maintenance Schedules

A preventive maintenance program should be established for all Stryker Medical equipment. Preventive maintenance may need to be performed more frequently based on the usage level of the product. Establish and follow a maintenance schedule and keep records of maintenance activity. Included are the recommended schedules for Stryker's model 6506, 6082 and 6370/6371/6377/6378/6391.

Please contact Stryker Technical Support at 800 784 4336 and select Option 2 for inquiries for all other products.

# Maintenance Schedules

## Stryker's Cot Fasteners Models 6370/6371/6377/6378/6391

The following schedule is intended as a general guide to maintenance. Bear in mind that such factors as weather, terrain, geographical location, and individual usage will alter the required maintenance schedule. If you are unsure as to how to perform these checks please contact your Stryker Service Technician.

Routine	Every			
	1 Month	3 Months	6 Months	12 Months
Verify the ambulance cot and fastener fit and function properly.				X
All fasteners are secure (reference all assembly drawings).		X		

If you are in doubt as to what intervals to follow in maintaining your product, consult your Stryker Service Technician.

# Maintenance Schedules

## Stryker's MX-PRO® R3 Ambulance Cot Model 6082

Inspect your unit with the following checklist every 1-6 months depending on the number of calls per month.

Operation	Schedule	Procedure
Cleaning and Disinfecting	Each Use.	See <a href="#">page 38</a>
Inspection	For 1-25 calls per month, inspect cot every 6 months	See below for checklist
	For 26-200 calls per month, inspect cot every 3 months	
	For 200+ calls per month, inspect cot monthly.	

### CHECKLIST

- \_\_\_\_\_ All fasteners secure (reference all assembly drawings)
- \_\_\_\_\_ All welds intact, not cracked or broken
- \_\_\_\_\_ No bent or broken tubing or sheet metal
- \_\_\_\_\_ No debris in wheels
- \_\_\_\_\_ All wheels secure, rolling and swiveling properly
- \_\_\_\_\_ Optional wheel lock holds wheel securely when on and clears wheel when off
- \_\_\_\_\_ Siderails move and latch properly
- \_\_\_\_\_ Backrest operating properly
- \_\_\_\_\_ Optional accessories intact and operating properly
- \_\_\_\_\_ Height positioning latch functioning properly
- \_\_\_\_\_ Cot secure in each height position
- \_\_\_\_\_ Undercarriage folds properly
- \_\_\_\_\_ Breakaway head section operating properly
- \_\_\_\_\_ Safety bar operating properly
- \_\_\_\_\_ Foot rest operating properly
- \_\_\_\_\_ No rips or cracks in mattress cover
- \_\_\_\_\_ Body restraints intact and working properly
- \_\_\_\_\_ Lubricate base tubes (optional)

# Maintenance Schedules

## **Stryker's Power-PRO XT Model 6506**

The following schedule is intended as a general guide to maintenance. Bear in mind that such factors as weather, terrain, geographical location, and individual usage will alter the required maintenance schedule. If you are unsure as to how to perform these checks please contact your Stryker service technician. If you are in doubt as to what intervals to follow in maintaining your product, consult your Stryker service technician. Use the hour meter to determine the frequency for preventive maintenance procedures. Check each routine and replace damaged or worn parts if necessary.

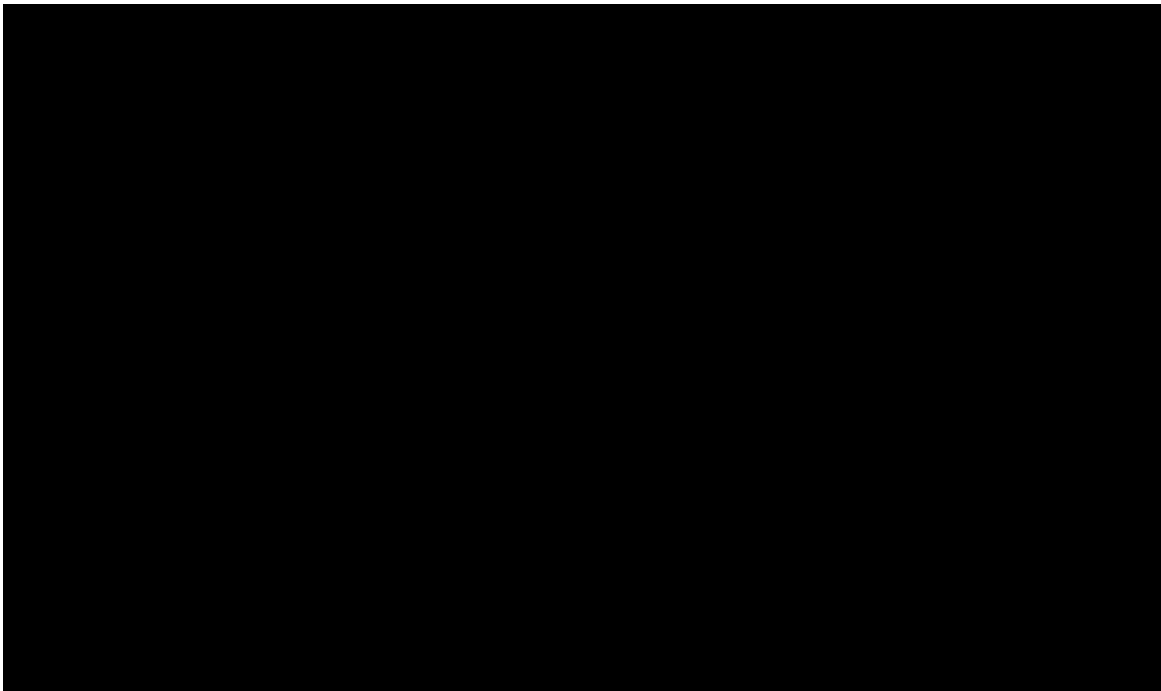

# Maintenance Schedules

## Stryker's Power-PRO XT Model 6506

